

M17A-UL / M17AB-UL / M17AC-UL / M17ACS-UL / M17AF-UL

General Description

- Warm air high speed hand dryer recommended for very high traffic areas.
- Surface mounted ADA-compliant.
- Maximum robustness and vandal-proof.
- Energy efficient, it only consumes 2.8 watts per drying cycle.
- Building Green Approved & offering LEED Credits.
- HEPA media filter cartridge which filters solid particles in suspension, improving air quality.
- Universal voltage.



Please mark the selected item

Components & Materials

- M17A-UL: 1/16" (1.5 mm) thick one-piece steel cover; white epoxy finish
- M17AB-UL: 1/16" (1.5 mm) thick one-piece steel cover; black epoxy finish
- M17AC-UL: 1/16" (1.5 mm) thick one-piece stainless steel cover; bright finish
- M17ACS-UL: 1/16" (1.5 mm) thick one-piece stainless steel cover; satin finish
- M17AF-UL: 3/16" (4.5 mm) thick one-piece cast iron cover, white porcelain finish
- MOTOR: High speed motor class F, with self-resettable safety cut-out and adjustable speed between 23,000 and 32,000 rpm. This regulation is carried out manually by means of a potentiometer located on the electronic board to adjust the power consumption of the dryer. The motor has been configured to have a smooth start to extend its life.
- ELECTRONIC DETECTION SENSOR: by infrared beam with detection distance adjustable by potentiometer between 2" and 8". It incorporates a safety system that detects any fixed target and makes hand dryer stop automatically in case a fixed object is placed in front of the sensor. In addition it has an automatic disconnection system of the unit after the 30 seconds of continuous use of the dryer.
- 500 W HEATING ELEMENT: with a self-resettable safety cut-out. It can be switched off manually with an ON/OFF micro switch located on the electronic board, allowing to regulate the power consumption of the hand dryer.
- BASE PLATE: made of aluminum, it incorporates acoustic dampening elements (silent-blocks) for the suppression of mechanical vibrations.
- FAN SCROLL: made with Polyamide 6 (PA 6) incorporating a flame retardant additive (UL 94 V 0) that increases the resistance to plastic ignition and once ignited reduces the rate of flame propagation.
- HEPA MEDIA FILTER CARTRIDGE: Filters solid particles in suspension, significantly improving air quality. This filter traps micro particles in the air such as pollen, dust mites, fungi, tobacco smoke, etc..
- ODOR NEUTRALIZER TABLET: an optional odor neutralizer tablet for a cleaner and more pleasant atmosphere in the bathroom is available (Code RCPOM14).
- WALL FIXING ELEMENTS: stainless steel screws for brick wall with their corresponding plastic plugs are provided with the hand dryer.

Technical Specifications

Voltage - 100-120V; 208V; 220-240V	Total power - 180- 850 W
Frequency - 50/ 60 Hz	Motor Power - 350 W
Insulation - Grounding required (Class I)	Heating element: 0 or 500W
Dimensions	Consumption
M17A/AC/AB/ACS 10 1/2"H x 11 1/2"W x 4"D	H. Element OFF: 2.5 – 3.5A
M17AF 10-5/8"H x 11-5/8"W x 4"D	H. Element ON: 4.8 – 7A
Weight - M17A/AC/AB/ACS - 8.4 Lbs.	r.p.m. - 23,000-32,000 rpm
M17AF - 15,65 Lbs.	
Effective airflow - 20-27 CFM	Air temperature – (at 4" distance/ T amb. 77 °F) 93-109 °F
Max air velocity - 250 mph/ 22,000 LFM	Drying time - 10 – 12 sec
Protection level - IP23	Noise level (at 79") - 57 – 65 dBA



code
M17A-UL
material
steel
finish
white epoxy



code
M17AB-UL
material
steel
finish
black epoxy



code
M17AC-UL
material
stainless steel
AISI 304
finish
bright



code
M17ACS-UL
material
stainless steel
AISI 304
finish
satin



code
M17AF-UL
material
cast iron
finish
white porcelain
enamelled coating

Operation

Place hands under the air outflow valve. The dryer will start automatically, and go on with no interruption as long as the hands are kept in the detection range of the sensor. The appliance will stop 2 seconds after the hands are removed from the airflow.



Saniflow Corp reserves the right to make changes and/or modifications to the products and their specifications without warning or notice.

Installation

Verify all rough-in dimensions prior to installation. Hand dryers require a dedicated circuit and must be properly grounded. A GFCI (Ground fault circuit interrupter) is recommended. One side of dryer should be mounted to a stud.

Certificates & Qualifications

Unit shall be UL and CSA approved, according to UL 499; CSA C22.2 Standards and Building Green Approved. UL and CSA approved according to UL 499 and CSA C22.2 Standards.

N° dryers to be fitted

- In toilet areas with a normal frequency of use and only one wash-basin: 1 dryer.
- In toilet areas with a normal frequency of use and more than one wash-basin: 1 dryer for each 2-3 wash-basins.
- 1 row of 4 wash basins: 2 dryers; 1 row of 6 wash basins: 3 dryers; 1 row of 8 wash basins: 4 dryers.
- In toilet areas with high traffic and more than one wash-basin: 2 dryers for each 3 wash-basins.
- 1 row of 4 wash basins: 3 dryers; 1 row of 6 wash basins: 4 dryers; 1 row of 8 wash basins: 5 dryers.

Ideal location

Between the wash-basin and exit. It is not recommended to install dryer between wash-basins, next to urinals, lavatories and showers. If installing automatic dryers over marble surface or ledge, the minimum distance from the dryer to the ledge must be 15-3/4". It is recommended that hand dryers be distributed throughout the washroom area to avoid overcrowding.

Guide Specification

Surface-mounted ADA compliant hand dryer shall have a 1/16" thick steel cover with white epoxy finish (M17A-UL), or a 1/16" thick steel cover with black finish (M17AB-UL), or a 1/16" thick stainless steel cover with bright finish (M17AC-UL), or a 1/16" thick stainless steel cover with satin finish (M17ACS-UL), or a 3/16" thick cast iron with white porcelain enamelled coating (M17AF-UL). Hand dryer shall include aluminum base plate 1/8" thick, infrared sensor adjustable (2" to 8") via potentiometer, universal brush motor fully adjustable (23,000-32,000 RPM) via potentiometer as well and HEPA media filter cartridge which filters solid particles in suspension, significantly improving air quality. Dryer shall operate at 57-65 dBA while delivering 20-27 CFM of air at 109 °F (42°C) and 250 mph as maximum air velocity (Max - 22,000 LFM) during user controlled drying cycle. Dryer shall have a total power of 180 - 850 W with a consumption of 2.5 - 7 A. Heating element made of Ni-Cr and with a self-resettable safety cut-out. It can be switched off manually "ON / OFF" micro-switch located on the electronic board, allowing to regulate the power consumption of the hand dryer. In case of motor failure the heating element is immediately switched off automatically.





Unit shall be UL and CSA approved, according to UL 499, CSA C22.2 standards, and Building Green Approved.

Overall dimensions:

M17A, M17AB, M17AC, M17ACS: 10 1/2"H x 11 1/2"W x 4"D (270mm x 290 mm x 100 mm)

M17AF: 10-5/8"H x 11-5/8"W x 4"D (270 mm x 295 mm x 102 mm)

Recommended heights from floor

				
	Male	Female	Child	Disabled
x To top of machine	56" / 142 cm	54" / 137 cm	46" / 117 cm	48" / 122 cm
y To mounting bracket screw	55" / 140 cm	53" / 135 cm	45" / 115 cm	47" / 120 cm
z To sensor top	46" / 117 cm	44" / 112 cm	36" / 92 cm	38" / 97 cm

MOUNTING

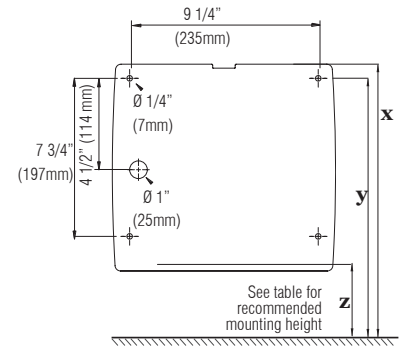

M17A-UL / M17AB-UL / M17AC-UL / M17ACS-UL

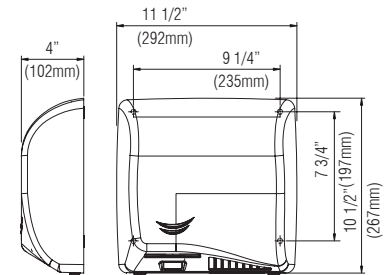

M17AF-UL

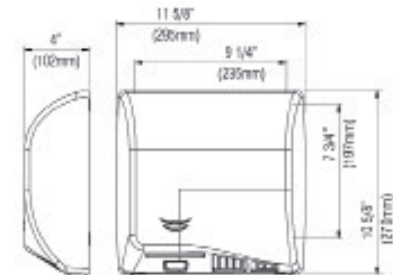

Serial mounting

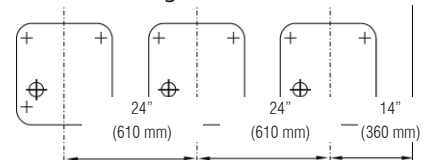

Job:

Model number:

Variations:

Architect / Engineer:

Contractor:

Customer / Wholesaler:

City / State / Country:

Date:

Quantity:

Saniflow Corp reserves the right to make changes and/or modifications to the products and their specifications without warning or notice.

Allied Hand Dryer, Ltd.
706 W Summit Ave
San Antonio, TX 78212

800.535.4393
210.733.5918
210.308.5924 Fax

www.handdryer.com
sales@handdryer.com